

## Table Top Rack Cabinets Heavy Duty - Ventilated (RCHV Series)



### Features:









- Heavy duty, 16-gauge steel, 19" table top rack cabinet...
- Ventilated on both sides & optimized per size to allow natural air convection...
- For solid side versions link to our [RCHS series](#)...
- Panel rails are infinitely adjustable (front to back), round hole punched for 10-32 clip-nuts to full EIA hole centers (5/8 - 5/8 - 1/2 inch spacing)...
- Includes two pairs of rails (for rear support of heavier equipment), rubber feet, black ABS plastic handles, a starter pack of 10-32 clip nuts & matching 1421ABK black screws...
- Supplied unassembled (four cabinet pieces & four rails), shipped in a flat pack container for handling ease & protection (see photo below)...
- Simple assembly using one bolt in each corner to lock the sides to the top and bottom (hardware included)...
- Overall width 21"...
- Overall height 2" over panel space...
- Front & back lip is .585" so usable depth is reduced by 1.17"
- Recommended maximum weight (RCHV1902824 tested) - 800 pounds...
- Rugged textured powder paint finish...
- Stocked in Black & Light Gray (RAL7035)...

### 17.5" Deep models:











Part Number	Color	PDF Reader File	AutoCAD .dxf File (zipped)	Panel Height		Number of Clip Nuts & Screws Included	Wt. lbs.
				Inches	Units		
<a href="#">RCHV1900817BK1</a> <a href="#">RCHV1900817CG1</a> <a href="#">RCHV1900817LG1</a>	Black Beige Light Gray	75K	79K	8.75	5	8	38
<a href="#">RCHV1901017BK1</a> <a href="#">RCHV1901017CG1</a> <a href="#">RCHV1901017LG1</a>	Black Beige Light Gray	75K	80K	10.50	6	16	40
<a href="#">RCHV1901417BK1</a> <a href="#">RCHV1901417CG1</a> <a href="#">RCHV1901417LG1</a>	Black Beige Light Gray	102K	109K	14.00	8	16	44
<a href="#">RCHV1901717BK1</a> <a href="#">RCHV1901717CG1</a> <a href="#">RCHV1901717LG1</a>	Black Beige Light Gray	113K	124K	17.50	10	16	50
<a href="#">RCHV1902217BK1</a> <a href="#">RCHV1902217CG1</a> <a href="#">RCHV1902217LG1</a>	Black Beige Light Gray	116K	128K	22.75	13	16	54
<a href="#">RCHV1902817BK1</a> <a href="#">RCHV1902817CG1</a> <a href="#">RCHV1902817LG1</a>	Black Beige Light Gray	114K	129K	28.00	16	16	60

### 24.5" Deep models:



Part Number	Color	PDF Reader File	AutoCAD .dxf File	Panel Height		Number of Clip Nuts & Screws Included	Wt. lbs.
				Inches	Units		
<a href="#">RCHV1901024BK1</a> <a href="#">RCHV1901024CG1</a> <a href="#">RCHV1901024LG1</a>	Black Beige Light Gray	91K	94K	10.50	6	16	52
<a href="#">RCHV1901424BK1</a> <a href="#">RCHV1901424CG1</a> <a href="#">RCHV1901424LG1</a>	Black Beige Light Gray	121K	136K	14.00	8	16	58
<a href="#">RCHV1901724BK1</a> <a href="#">RCHV1901724CG1</a>	Black Beige			17.50	10	16	62

<b>RCHV1901724LG1</b>	Light Gray	125K	141K				
<b>RCHV1902224BK1</b>	Black			<b>22.75</b>	13	16	70
<b>RCHV1902224CG1</b>	Beige						
<b>RCHV1902224LG1</b>	Light Gray	124K	149K				
<b>RCHV1902824BK1</b>	Black			<b>28.00</b>	16	16	78
<b>RCHV1902824CG1</b>	Beige						
<b>RCHV1902824LG1</b>	Light Gray	124K	152K				

**31.5" Deep models:**

Part Number	Color	 Reader File	AutoCAD .dxf File	Panel Height		Number of Clip Nuts & Screws Included	Wt. lbs.
				Inches	Units		
<b>RCHV1901031BK1</b> <b>RCHV1901031LG1</b>	Black Light Gray	 97K	 108K	<b>10.50</b>	6	16	64
<b>RCHV1901431BK1</b> <b>RCHV1901431LG1</b>	Black Light Gray	 133K	 164K	<b>14.00</b>	8	16	68
<b>RCHV1901731BK1</b> <b>RCHV1901731LG1</b>	Black Light Gray	 145K	 176K	<b>17.50</b>	10	16	74
<b>RCHV1902231BK1</b> <b>RCHV1902231LG1</b>	Black Light Gray	 149K	 184K	<b>22.75</b>	13	16	86
<b>RCHV1902831BK1</b> <b>RCHV1902831LG1</b>	Black Light Gray	 152K	 191K	<b>28.00</b>	16	16	94

**Feature Views:**

<p><b>Ships Flat</b> <b>For Handling Ease &amp; Protection</b></p>  <p>Wood Ends Corner protectors nailed to wood ends Banded</p>	<p><b>Interior View</b> <b>With Infinitely Adjustable Panel Rails</b></p>  <p>Rails are infinitely adjustable (front to back) on amhnl struts Base punched for easy caster mounting</p>
<p><b>Panel Rails (Two Pair Included)</b> <b>With 10-32 Black Clip Nuts &amp; Mounting Hardware</b></p> 	

**Accessories:**



**Castors** - Part Number **1425PHD**

- **SOLD IN A SET OF 4**
- Base of cabinet is punched to accept this caster set
- 600# Mfg's specified weight capacity (Set of 4)
- Features ball bearing swivel and hard composition wheels
- Small foot print 2.125" x 15/16" hole mounting pattern
- Wheels are grey & 2" wheel diameter
- Includes mounting hardware



## Doors

- 16-gauge steel construction
- Both front & back of "RCHV" rack cabinets are punched to accept these doors
- Mounts either right or left hand hinge (door & cabinet are symmetrical)
- Includes installed lock and two keys
- Finished in rugged textured powder paint to match RCHS/RCHV enclosures
- Includes mounting hardware



Part Number	Color	PDF Reader File	AutoCAD .dxf File	Use With Cabinet Panel Height	Wt. lbs.
<b>RCHD1908BK1</b> <b>RCHD1908CG1</b> <b>RCHD1908LG1</b>	Black Beige Light Gray	17K	179K	8" (5 U)	5
<b>RCHD1910BK1</b> <b>RCHD1910CG1</b> <b>RCHD1910LG1</b>	Black Beige Light Gray	18K	192K	10.5" (6 U)	5
<b>RCHD1914BK1</b> <b>RCHD1914CG1</b> <b>RCHD1914LG1</b>	Black Beige Light Gray	19K	219K	14" (8 U)	6
<b>RCHD1917BK1</b> <b>RCHD1917CG1</b> <b>RCHD1917LG1</b>	Black Beige Light Gray	21K	246K	17.5" (10 U)	7
<b>RCHD1922BK1</b> <b>RCHD1922CG1</b> <b>RCHD1922LG1</b>	Black Beige Light Gray	22K	285K	22.75" (13 U)	9
<b>RCHD1928BK1</b> <b>RCHD1928CG1</b> <b>RCHD1928LG1</b>	Black Beige Light Gray	24K	329K	28" (16 U)	12



## Extra Panel Rails

- RCHV rack cabinets ship with two pair - order below for extra mounting capabilities
- **Sold in pairs**
- Finished in rugged black textured powder paint
- Includes amhal strut mounting hardware (black clip nuts are not included)

Part Number	Use With Cabinet Panel Height
<b>RCHR1908</b>	8" (5 U)
<b>RCHR1910</b>	10.5" (6 U)
<b>RCHR1914</b>	14" (8 U)
<b>RCHR1917</b>	17.5" (10 U)
<b>RCHR1922</b>	22.75" (13 U)
<b>RCHR1928</b>	28" (16 U)



## Extra Spring Nuts - Part Number **1421SN**

- 1/4 - 20 Strut nut
- 1/4 - 20 x 1/2 bolt
- Used only in our RCHS & RCHV table top rack cabinets - handy for mounting of other

- equipment to the horizontal struts
- **Sold in packages of 8 (8 spring nuts and 8 bolts) as shown**



## Replacement Rubber Feet - Part Number **1421RC24**

- RCHV rack cabinets ship with four feet included - order these for replacement
- **Sold in package of 20**



PART No. RCHV1902831

for more information visit  
[www.hammfg.com](http://www.hammfg.com)

Data subject to change without notice.  
Isometric drawing not to scale.  
Shipped knockdown for handling ease  
& protection.

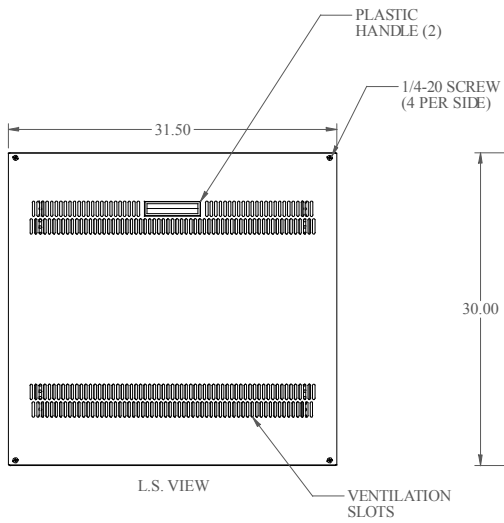
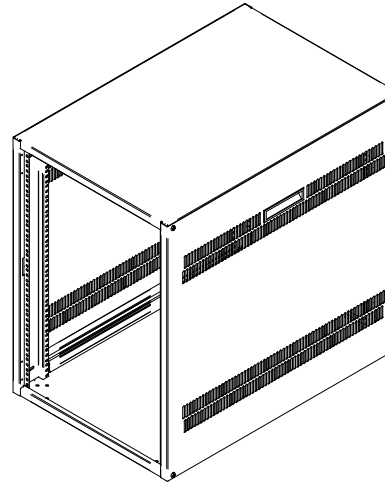

L.S. VIEW

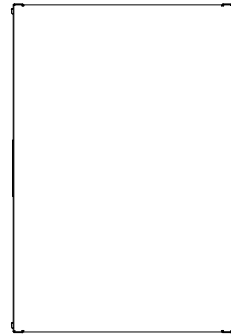

TOP VIEW

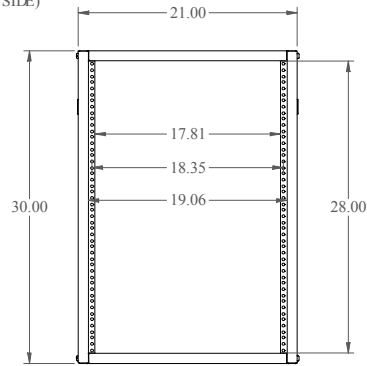

FRONT VIEW

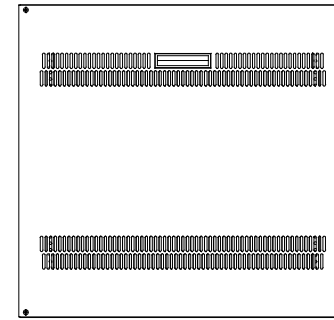

R.S. VIEW

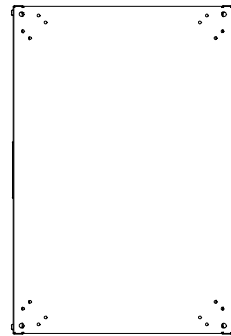

BOTTOM VIEW